

AC INFINITY

CLOUDLAB SERIES

ADVANCE PROPAGATION TENT

USER MANUAL

WELCOME

Thank you for choosing AC Infinity. We are committed to product quality and friendly customer service. If you have any questions or suggestions, please don't hesitate to [contact](#) us. Visit www.acinfinity.com and click contact for our contact information.

EMAIL

support@acinfinity.com

WEB

www.acinfinity.com

LOCATION

Los Angeles, CA

MANUAL CODE CBK2311X1

PRODUCT

Advance Propagation Tent

MODEL

AC-CBK322

UPC-A

819137024588

MANUAL INDEX

Manual Index	Page 5
Product Warning	Page 6
Key Features	Page 7
Product Contents	Page 8
Installation	Page 9
Configurations	Page 17
Controller Plate Setup	Page 21
Mounting Guide	Page 22
Other AC Infinity Products	Page 23
Warranty	Page 24

PRODUCT WARNING



TO REDUCE THE RISK OF INJURY TO PERSONS OR DAMAGE TO PRODUCTS, OBSERVE THE FOLLOWING:

1. Read all instructions before installing and using this product.
2. Mounting bars will not support the weight of LED grow lights or heavy ventilation equipment.
3. Safety precautions should be exercised during the installation, operation, and maintenance of this product. Inappropriate installation will void this product's warranty.

KEY FEATURES

MULTIPURPOSE DESIGN

Versatile frame features multiple shelving and device mounting options to best fit your propagation needs.

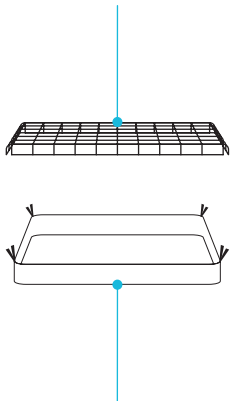

WATERPROOF LINING

Spill-proof drip tray catches water, soil, and other debris to ensure easy cleanup and stop any leakage.

HEAVY-DUTY CANVAS

2000D mylar canvas blocks light from leaking through while intensifying reflectivity and locking in humidity.

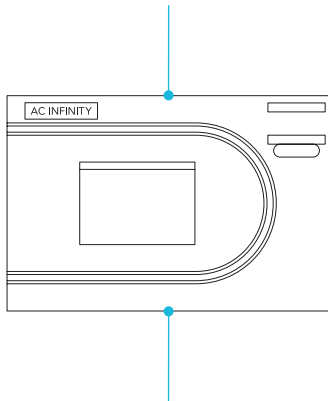

HIGHLY DURABLE FRAME

22mm steel poles provide a steady structure while included mounting bars can support additional grow devices.

CONVENIENT VIEWING

Clear and easy-to-adjust windows allow you to observe your growing plants without affecting the environment.

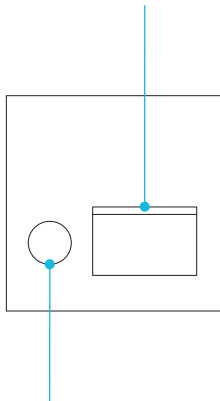

DUCTWORK ACCESS

Dual double-cinched ports support ducting installations to route airflow and facilitate fresh air exchange.

PRODUCT CONTENTS

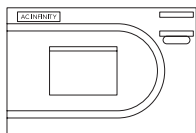

PROPAGATION
TENT
(x1)

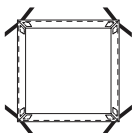

24 x 24 IN.
CATCH TRAY
(x1)

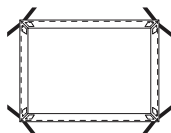

24 x 36 IN.
CATCH TRAY
(x1)

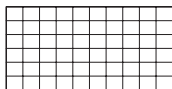

SHELF
RACK
(x2)



CONTROLLER
PLATE
(x1)



FLAT-HEAD
SCREW
(x4)



P-HEAD
SCREW
(x4)



M3 HEX
NUT
(x9)



M5
SCREW
(x8)



M5 HEX
NUT
(x9)



HOOK-AND-
LOOP PAD
(x6)



ADHESIVE
SILICONE PAD
(x12)



A1
POLE
(x4)



A2
POLE
(x4)



A3
POLE
(x4)



MOUNTING
BAR - 2FT
(x4)



MOUNTING
BAR - 3FT
(x2)



D1
PIECE
(x8)



HOOK-AND-
LOOP STRAP
(x12)



CABLE
TIE
(x4)



SUPPORT
CLAMP
(x8)

INSTALLATION

TENT ASSEMBLY

STEP 1

Insert two (A1) and two (A3) poles into the (D1) corner pieces, with the (A1) and (A3) poles perpendicular to each other, as shown here.

Repeat this step to create both bases.

When assembling your propagation tent, make sure the feet of each corner (D1) piece faces the floor with the arrow facing down.

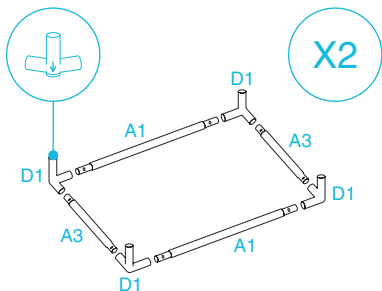

STEP 2

Insert the four (A2) poles into one of the bases, then insert the other base to the four (A2) poles to complete the frame.

Make sure the markings on each (A1) pole are pointed in the same direction.

Make sure the markings on each (A2) pole are pointed in the same direction.

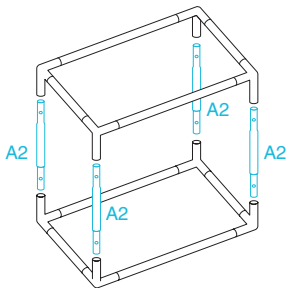

INSTALLATION

TENT ASSEMBLY

STEP 3

Unzip the tent so that three of the walls lay flat.

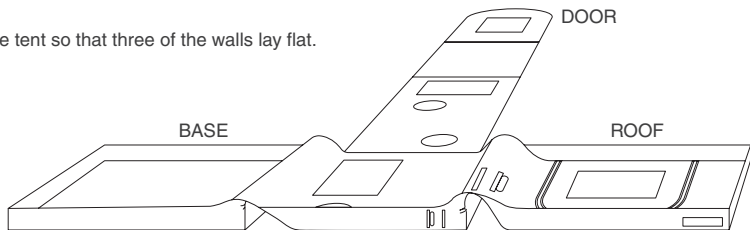

STEP 4

Guide the frame into the floor of the tent, making sure its corners meet the tent's corners.

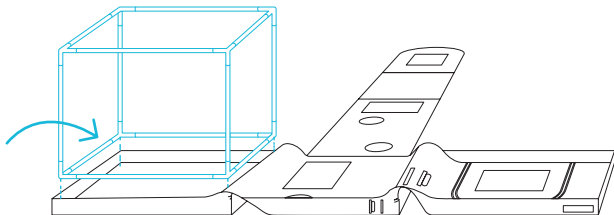

INSTALLATION

TENT ASSEMBLY

STEP 5

Pull the roof over the assembled frame.

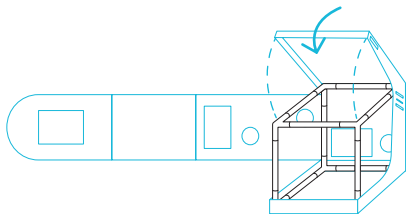

STEP 6

Pull the upper and lower zippers to close the walls and door.

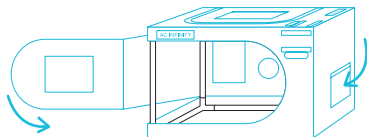

INSTALLATION

TENT ASSEMBLY

STEP 7

You can neatly hold the window wall open any time by using its attached hook-and-loop strap.

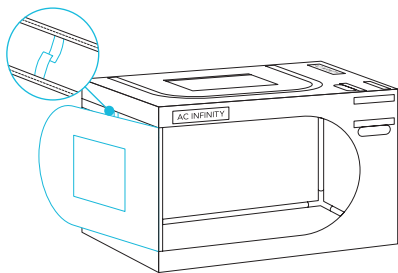

STEP 8

Insert the catch tray and secure the hook-and-loop straps around the poles. Line the tent floor with the appropriate catch tray for the orientation you choose.

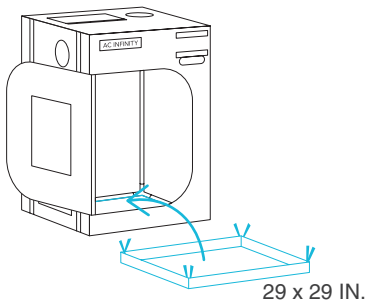
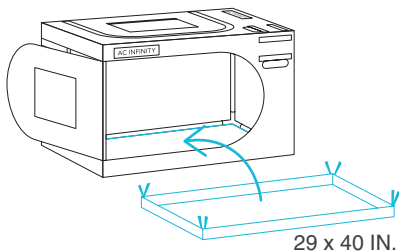

INSTALLATION

MOUNTING BARS

PRE-INSTALLATION

You may use the included mounting bars to customize your propagation tent and fit your desired application.

Remove the tent walls before installing the mounting bars.

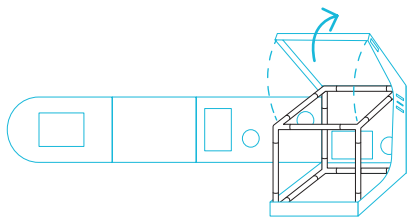

STEP 1

Place the adhesive silicone pads at the ends of each mounting bar, matching the correct size pads on both sides so that it fits snug on the propagation tent poles.

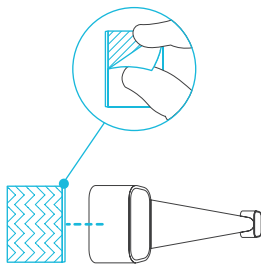

INSTALLATION

MOUNTING BARS

STEP 2

Route the hook-and-loop straps through the bar opening located at its ends, making sure the buckle is outside and the padded side is inside.

This strap can loop around up to two bar openings.



OR



STEP 3

Wrap the hook-and-loop strap around the propagation tent pole and route it through its buckle. Tighten and secure the strap.

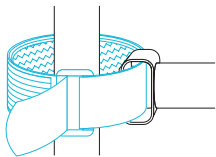

OR

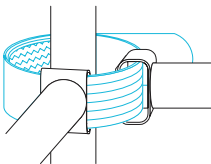

INSTALLATION

MOUNTING BARS

STEP 4

Open the support clamp around the bar.

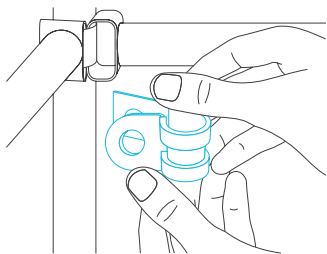

STEP 5

Tighten and secure the clamp with the nut and screw so that its flat side is parallel to your propagation tent's walls.

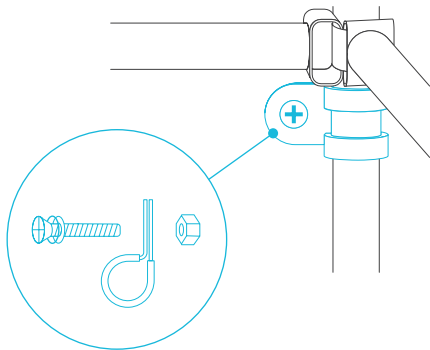

INSTALLATION

MOUNTING BARS

STANDARD ORIENTATION

The standard orientation will prevent your propagation tent from bowing.

This configuration can also be used as a support system that allows elastic trellis nets to hook onto the side bars.

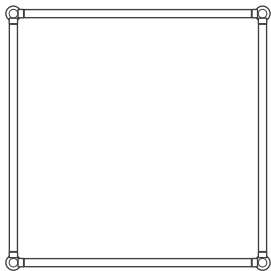

SUPPORT ORIENTATION

The support orientation will provide general use support throughout your propagation tent.

This configuration can be used to support your plant's weight, carry accessories, or produce separate spaces within your propagation tent.

It will also enable targeted environmental adjustments such as inter-canopy lighting when using grow light bars or spot airflow when using clip-on fans.

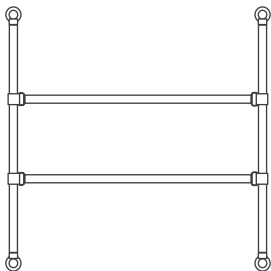

CONFIGURATIONS

HORIZONTAL ORIENTATION

STEP 1

Install two 3 ft. mounting bars against the front and back walls.

You may install 2 ft. mounting bars onto the roof to support your desired lighting fixtures.

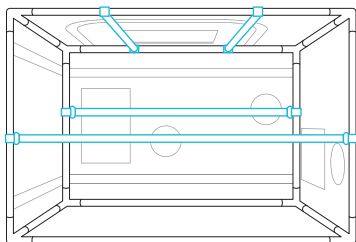

STEP 2

Place shelf racks onto the 3 ft. mounting bars as desired.

You may place humidity domes and/or seedling mats on these shelf racks or on the tent floor.

You may also magnetically set LED light bars onto the 2 ft. mounting bars or below the shelf racks as needed.

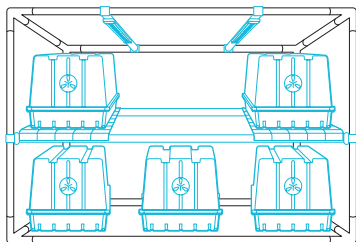

Grow products shown sold separately

CONFIGURATIONS

VERTICAL ORIENTATION

STEP 1

Install the four 2 ft. mounting bars onto the side walls.

You may install additional 2 ft. mounting bars (sold separately) above this setup to create another level of shelving.

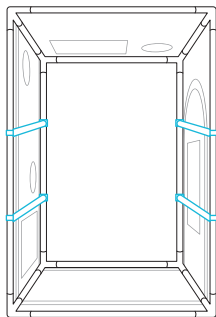

STEP 2

Place shelf racks onto the 2 ft. mounting bars as desired.

You may place humidity domes and/or seedling mats on these shelf racks or on the tent floor.

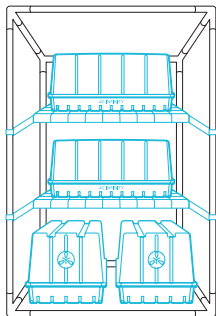

Grow products shown sold separately

CONFIGURATIONS

GROW TENT ORIENTATION

STEP 1

Install two 2 ft. mounting bars onto the side walls.

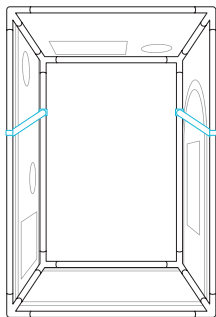

STEP 2

Place shelf racks onto the 2 ft. mounting bars as desired.

You may place humidity domes and/or seedling mats on these shelf racks and utilize the space below them to house plants.

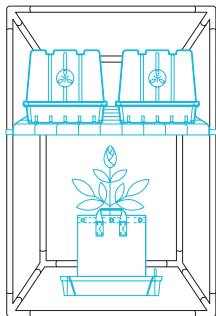

Grow products shown sold separately

CONFIGURATIONS

GROW TENT ORIENTATION (ALTERNATIVE)

STEP 1

Install the four 2 ft. mounting bars onto the side walls, back wall, and roof.

You may use the mounting bars to support grow equipment as needed.

You may use this configuration to house larger plants.

Grow products shown sold separately

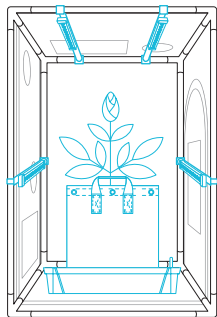

CONTROLLER PLATE SETUP

STEP 1

Mount your controller onto the included controller plate.

Use the included screws to mount an AC Infinity controller. Use the controller adhesive to attach a non-AC Infinity controller.

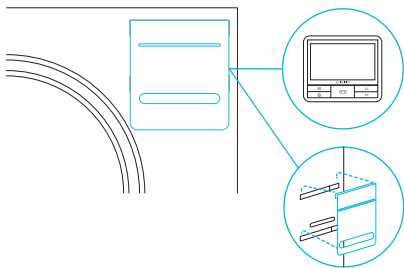

STEP 2

Route your devices' power connectors through the opening inside and plug them into your controller.

Plug the probe into your controller and route its cables through the opening.

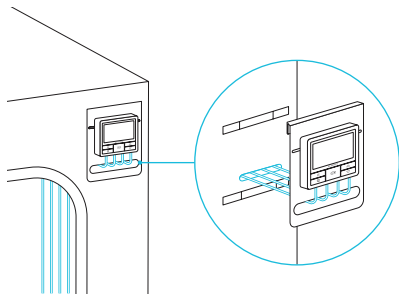

MOUNTING GUIDE

HARDWARE MOUNTING

Screw the bolts into the slot or mounting holes at the upper half of the plate.

Hang your controller by the bolts using the holes on the backside.

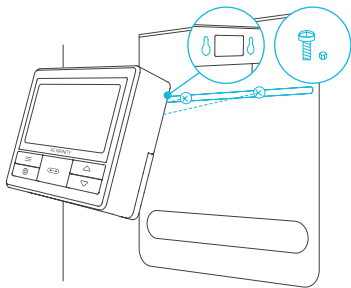

MAGNET MOUNTING

You may also magnetically mount your controller onto the steel plate if it has a magnet located behind its label.

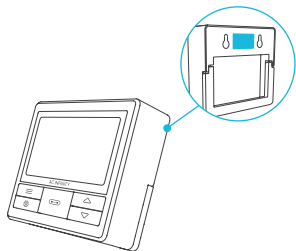

WARRANTY

This warranty program is our commitment to you, the product sold by AC Infinity will be free from defects in manufacturing for a period of two years from the date of purchase. If a product is found to have a defect in material or workmanship, we will take the appropriate actions defined in this warranty to resolve any issues.

The warranty program applies to any order, purchase, receipt, or use of any products sold by AC Infinity or our authorized dealerships. The program covers products that have become defective, malfunctioned, or expressively if the product becomes unusable. The warranty program goes into effect on the date of purchase. The program will expire two years from the date of purchase. If your product becomes defective during that period, AC Infinity will replace your product with a new one or issue you a full refund.

The warranty program does not cover abuse or misuse. This includes physical damage, submersion of the product in water, incorrect installation such as wrong voltage input, and misuse for any reason other than intended purposes. AC Infinity is not responsible for consequential loss or incidental damages of any nature caused by the product. We will not warrant damage from normal wear such as scratches and dings.

Contact our dealers department at dealers@acinfinity.com or (626) 838-4656 for more information about our dealers and distributors program. Contact our customer service department at support@acinfinity.com or 626-923-6399 for product and warranty assistance. Our business hours are Monday through Friday, 9:00 am to 5:00 pm PST.



If you have any issues with this product, contact us and we'll happily resolve your problem or issue a full refund!

AC INFINITY PRODUCTS

Advance Grow Tents

The CLOUDLAB series is a line of grow tents designed to create ideal growing conditions and facilitate indoor plant cultivation year-round. Features 2000D thick Oxford canvas lined with inner diamond patterned mylar that maximizes grow light luminosity, and a reinforced frame with 150 lb. weight capacity.

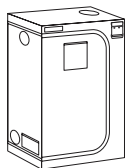

Humidity Dome

The humidity dome is designed to maintain moisture levels to create the ideal environment for seed germination. Each kit includes a base tray with a dome that is built with adjustable vents to control humidity levels. Height extender also included to provide a higher ceiling for propagation applications.

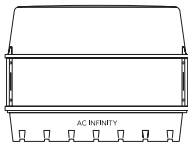

Grow Light Bars

The IONBEAM series is a line of grow light bars designed to maximize plant growth by accelerating your plant's photosynthesis. Features the latest LED technology to efficiently produce full-spectrum and targeted lighting, as well as magnetic mounting to use as inter-canopy lighting. Includes a digital controller with programming modes to schedule and activate ten intensity levels.

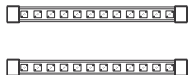

Discover the latest innovations in environmental controls at acinfinity.com

COPYRIGHT © 2023 AC INFINITY INC. ALL RIGHTS RESERVED

No part of the materials including graphics or logos available in this booklet may be copied, photocopied, reproduced, translated or reduced to any electronic medium or machine readable form, in whole or in part, without specific permission from AC Infinity Inc.

www.acinfinity.com